

SK35GD126ET

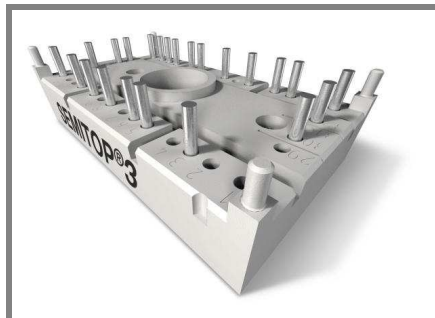

SEMITOP® 3

IGBT Module

SK35GD126ET

Preliminary Data

Features

- Compact design
- One screw mounting
- Heat transfer and isolation through direct copper bonded aluminium oxide ceramic (DCB)
- Ultrafast NPT technology IGBT
- CAL technology FWD
- Integrated NTC temperature sensor

Typical Applications*

- Inverter

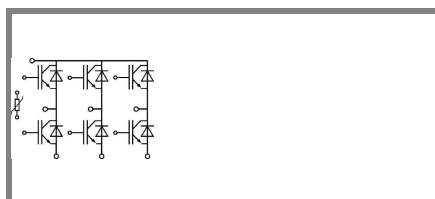

GD-ET

Absolute Maximum Ratings		$T_s = 25\text{ °C}$, unless otherwise specified	
Symbol	Conditions	Values	Units
IGBT			
V_{CES}	$T_j = 25\text{ °C}$	1200	V
I_C	$T_j = 150\text{ °C}$	$T_s = 25\text{ °C}$	40
		$T_s = 80\text{ °C}$	32
I_{CRM}	$I_{CRM} = 2 \times I_{Cnom}$	70	A
V_{GES}		± 20	V
t_{psc}	$V_{CC} = 600\text{ V}; V_{GE} \leq 20\text{ V}; T_j = 125\text{ °C}$ $V_{CES} < 1200\text{ V}$	10	μs
Inverse Diode			
I_F	$T_j = 150\text{ °C}$	$T_s = 25\text{ °C}$	34
		$T_s = 80\text{ °C}$	23
I_{FRM}	$I_{FRM} = 2 \times I_{Fnom}$	70	A
Module			
$I_{t(RMS)}$			A
T_{vj}		-40 ... +150	$^{\circ}\text{C}$
T_{stg}		-40 ... +125	$^{\circ}\text{C}$
V_{isol}	AC, 1 min.	2500	V

Characteristics		$T_s = 25\text{ °C}$, unless otherwise specified			
Symbol	Conditions	min.	typ.	max.	Units
IGBT					
$V_{GE(th)}$	$V_{GE} = V_{CE}, I_C = 1,5\text{ mA}$	5	5,8	6,5	V
I_{CES}	$V_{GE} = 0\text{ V}, V_{CE} = V_{CES}$	$T_j = 25\text{ °C}$			mA
		$T_j = 125\text{ °C}$			mA
I_{GES}	$V_{CE} = 0\text{ V}, V_{GE} = 20\text{ V}$	$T_j = 25\text{ °C}$		600	nA
		$T_j = 125\text{ °C}$			nA
V_{CE0}		$T_j = 25\text{ °C}$	1	1,2	V
		$T_j = 125\text{ °C}$	0,9		V
r_{CE}	$V_{GE} = 15\text{ V}$	$T_j = 25\text{ °C}$	20	26	$\text{m}\Omega$
		$T_j = 125\text{ °C}$	31		$\text{m}\Omega$
$V_{CE(sat)}$	$I_{Cnom} = 35\text{ A}, V_{GE} = 15\text{ V}$	$T_j = 25\text{ °C}_{chiplev.}$	1,7	2,1	V
		$T_j = 125\text{ °C}_{chiplev.}$	2		V
C_{ies}	$V_{CE} = 25, V_{GE} = 0\text{ V}$	$f = 1\text{ MHz}$	2,5		nF
C_{oes}			0,132		nF
C_{res}			0,115		nF
$t_{d(on)}$	$R_{Gon} = 15\ \Omega$	$V_{CC} = 600\text{ V}$ $I_C = 35\text{ A}$	85		ns
t_r			30		ns
E_{on}			4,6		mJ
$t_{d(off)}$	$R_{Goff} = 15\ \Omega$	$T_j = 125\text{ °C}$ $V_{GE} = \pm 15\text{ V}$	430		ns
t_f			90		ns
E_{off}			4,3		mJ
$R_{th(j-s)}$	per IGBT			1,05	K/W

SK35GD126ET

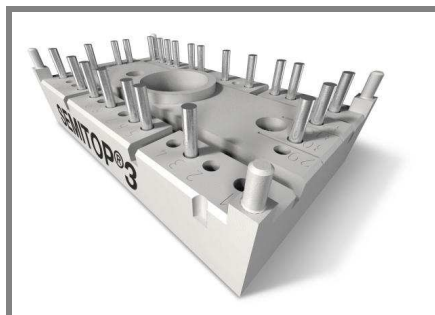

SEMITOP[®] 3

IGBT Module

SK35GD126ET

Preliminary Data

Features

- Compact design
- One screw mounting
- Heat transfer and isolation through direct copper bonded aluminium oxide ceramic (DCB)
- Ultrafast NPT technology IGBT
- CAL technology FWD
- Integrated NTC temperature sensor

Typical Applications*

- Inverter

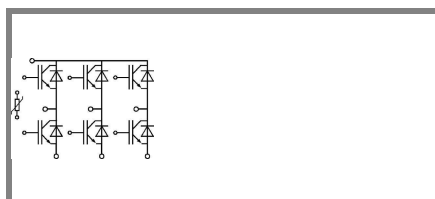

GD-ET

Characteristics			min.	typ.	max.	Units
Inverse Diode						
$V_F = V_{EC}$	$I_{Fnom} = 35 \text{ A}; V_{GE} = 0 \text{ V}$	$T_j = 25 \text{ }^\circ\text{C}_{\text{chiplev.}}$		1,8	2,1	V
		$T_j = 125 \text{ }^\circ\text{C}_{\text{chiplev.}}$		1,8		V
V_{F0}		$T_j = 25 \text{ }^\circ\text{C}$		1	1,1	V
		$T_j = 125 \text{ }^\circ\text{C}$		0,8		V
r_F		$T_j = 25 \text{ }^\circ\text{C}$		23	29	m Ω
		$T_j = 125 \text{ }^\circ\text{C}$		31		m Ω
I_{RRM}	$I_F = 35 \text{ A}$	$T_j = 125 \text{ }^\circ\text{C}$		43		A
Q_{rr}	$di/dt = -1330 \text{ A}/\mu\text{s}$			7		μC
E_{rr}	$V_{CC} = 600\text{V}$			2,9		mJ
$R_{th(j-s)D}$	per diode				1,7	K/W
M_s	to heat sink		2,25		2,5	Nm
w				30		g
Temperature sensor						
R_{100}	$T_s = 100^\circ\text{C} (R_{25} = 5\text{k}\Omega)$			493 \pm 5%		Ω

This is an electrostatic discharge sensitive device (ESDS), international standard IEC 60747-1, Chapter IX.

* The specifications of our components may not be considered as an assurance of component characteristics. Components have to be tested for the respective application. Adjustments may be necessary. The use of SEMIKRON products in life support appliances and systems is subject to prior specification and written approval by SEMIKRON. We therefore strongly recommend prior consultation of our personal.

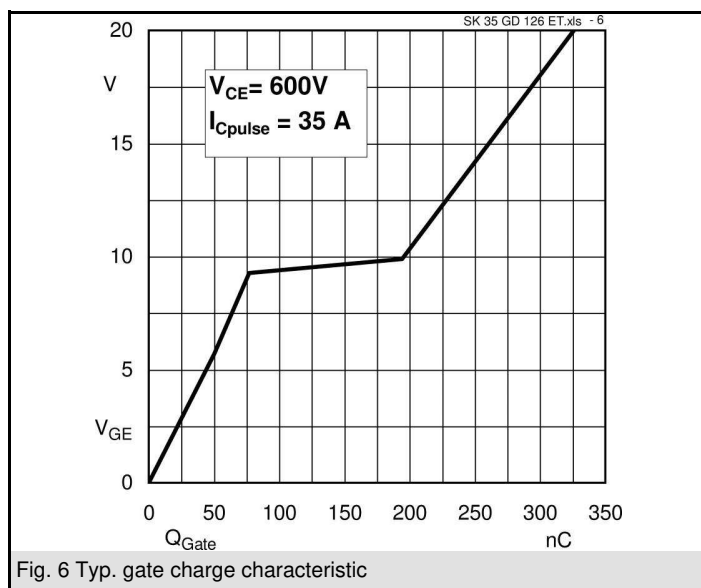
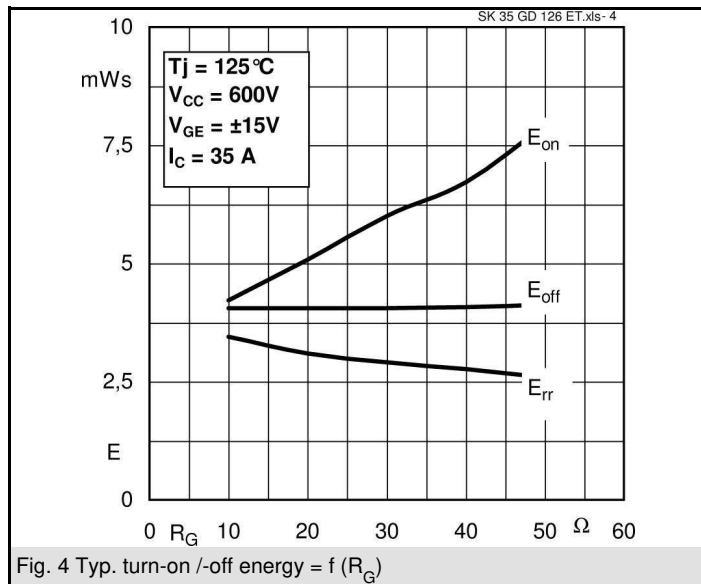
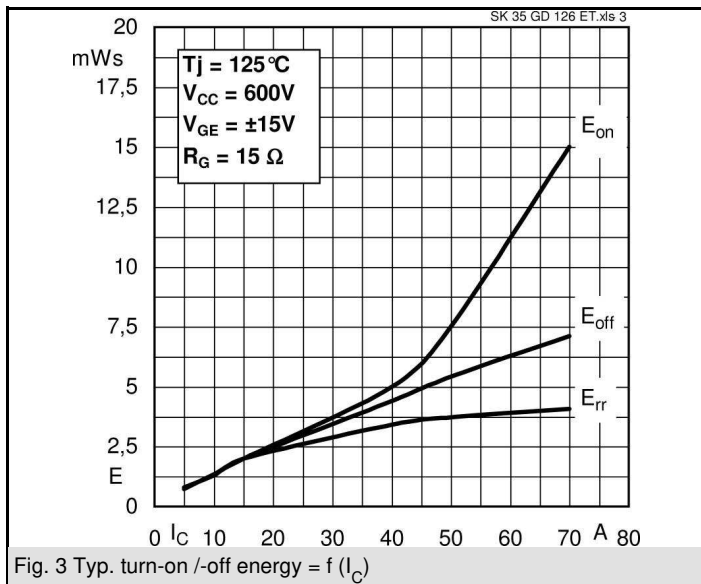
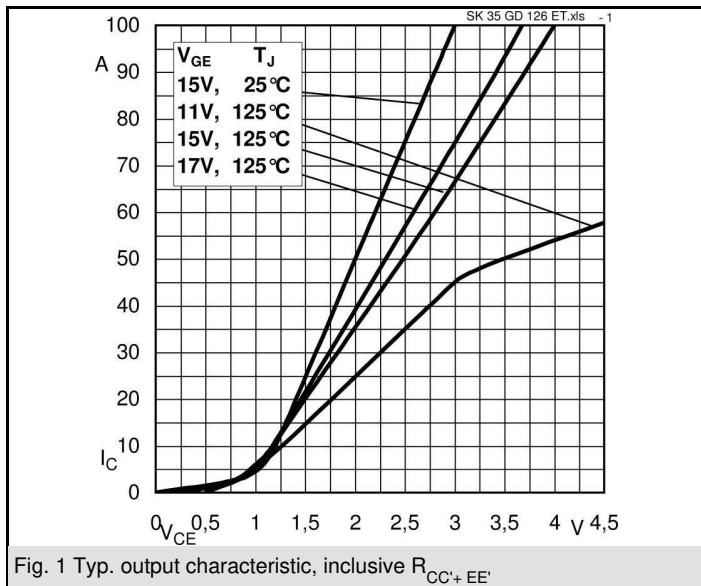

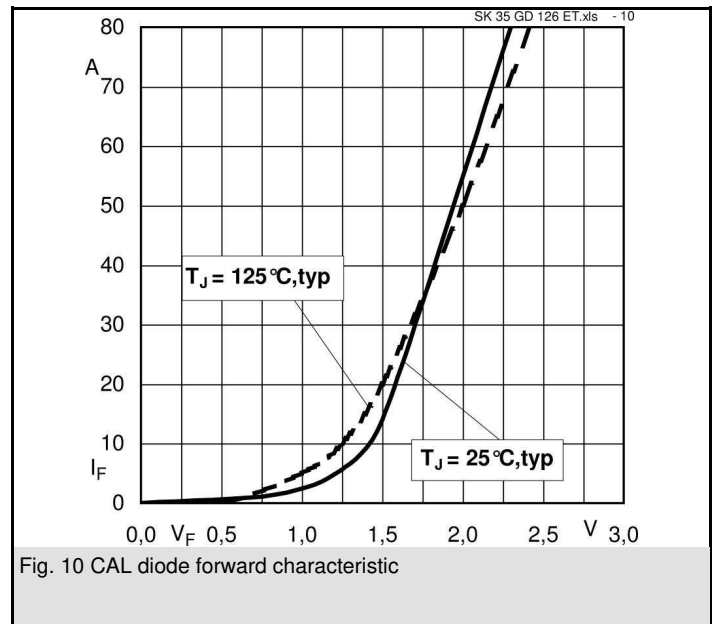
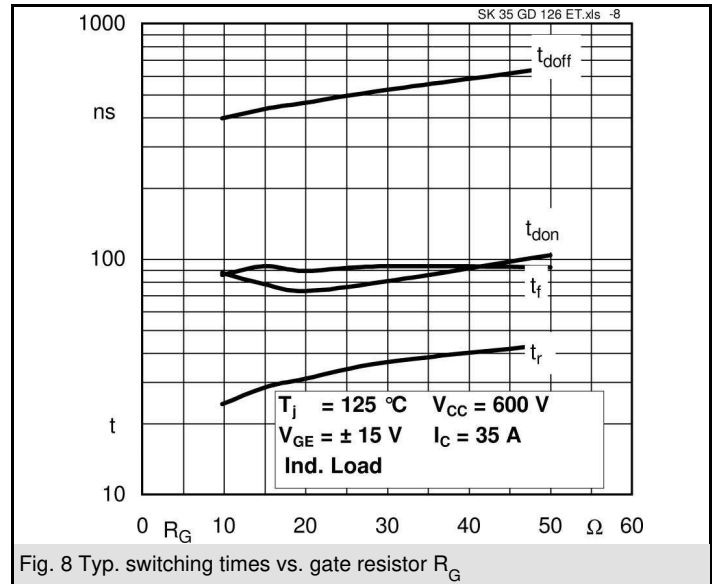
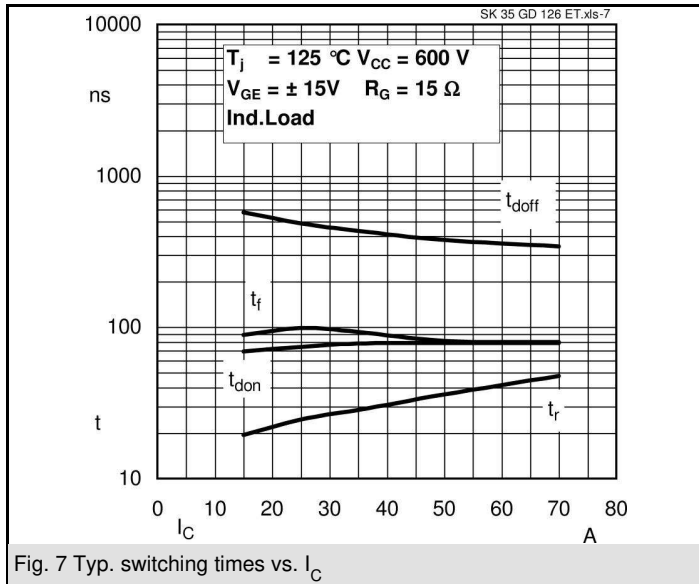

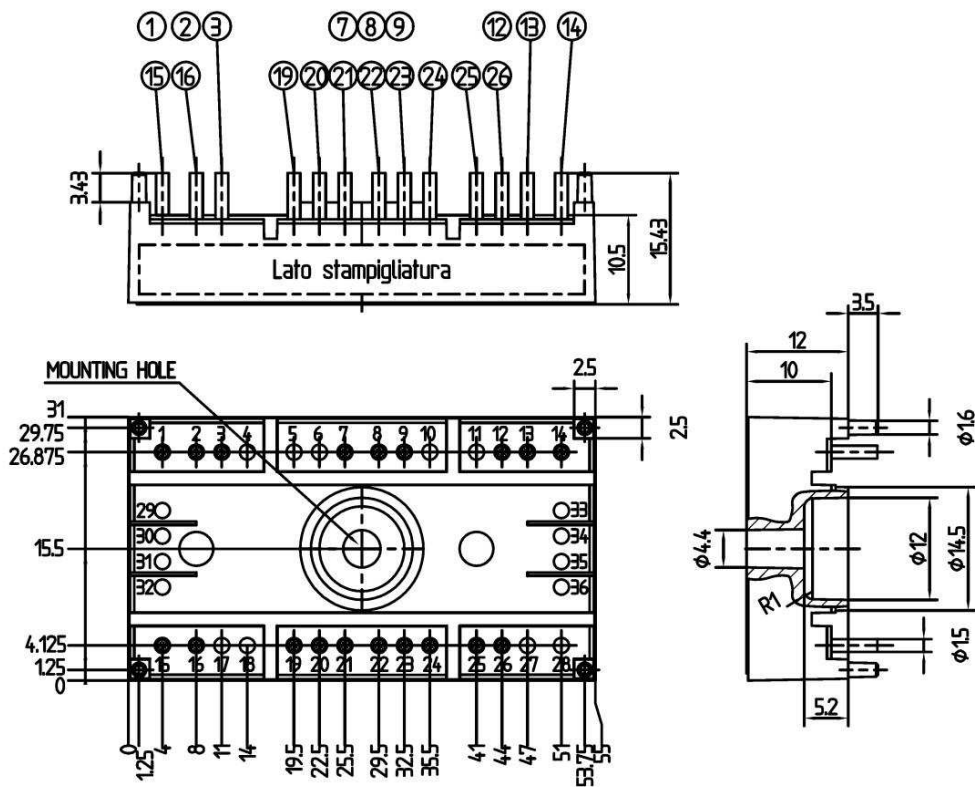

Case T52 (Suggested hole diameter, in the PCB, for solder pins and plastic mounting pins: 2mm)

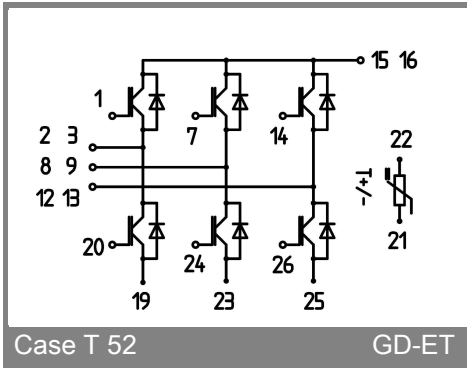

Case T 52

GD-ET