

# SKM195GB126D



## SEMITRANS® 2

### Trench IGBT Modules

#### SKM195GB126D

#### Features

- Trench = Trenchgate technology
- $V_{CE(sat)}$  with positive temperature coefficient
- High short circuit capability, self limiting to  $6 \times I_C$
- UL recognized, file no. E63532

#### Typical Applications\*

- AC inverter drives
- UPS
- Electronic welders

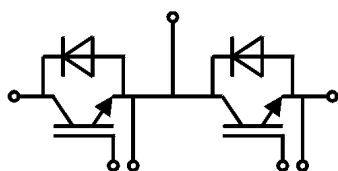

GB

#### Absolute Maximum Ratings

Symbol	Conditions	Values	Unit	
<b>IGBT</b>				
$V_{CES}$	$T_j = 25\text{ °C}$	1200	V	
$I_C$	$T_j = 150\text{ °C}$	$T_c = 25\text{ °C}$	220	A
		$T_c = 80\text{ °C}$	164	A
$I_{Cnom}$		150	A	
$I_{CRM}$	$I_{CRM} = 2 \times I_{Cnom}$	300	A	
$V_{GES}$		-20 ... 20	V	
$t_{psc}$	$V_{CC} = 600\text{ V}$ $V_{GE} \leq 15\text{ V}$ $V_{CES} \leq 1200\text{ V}$	$T_j = 125\text{ °C}$	10	$\mu\text{s}$
$T_j$		-40 ... 150	$^{\circ}\text{C}$	
<b>Inverse diode</b>				
$I_F$	$T_j = 150\text{ °C}$	$T_c = 25\text{ °C}$	143	A
		$T_c = 80\text{ °C}$	98	A
$I_{Fnom}$		100	A	
$I_{FRM}$	$I_{FRM} = 2 \times I_{Fnom}$	200	A	
$I_{FSM}$	$t_p = 10\text{ ms, sin } 180^{\circ}, T_j = 25\text{ °C}$	1110	A	
$T_j$		-40 ... 150	$^{\circ}\text{C}$	
<b>Module</b>				
$I_{t(RMS)}$		200	A	
$T_{stg}$		-40 ... 125	$^{\circ}\text{C}$	
$V_{isol}$	AC sinus 50 Hz, $t = 1\text{ min}$	4000	V	

#### Characteristics

Symbol	Conditions	min.	typ.	max.	Unit
<b>IGBT</b>					
$V_{CE(sat)}$	$I_C = 150\text{ A}$ $V_{GE} = 15\text{ V}$ chipelevel	$T_j = 25\text{ °C}$	1.71	2.10	V
		$T_j = 125\text{ °C}$	2.00	2.45	V
$V_{CE0}$	chipelevel	$T_j = 25\text{ °C}$	1	1.2	V
		$T_j = 125\text{ °C}$	0.9	1.1	V
$r_{CE}$	$V_{GE} = 15\text{ V}$ chipelevel	$T_j = 25\text{ °C}$	4.7	6	$\text{m}\Omega$
		$T_j = 125\text{ °C}$	7.3	9	$\text{m}\Omega$
$V_{GE(th)}$	$V_{GE} = V_{CE}, I_C = 6\text{ mA}$	5	5.8	6.5	V
$I_{CES}$	$V_{GE} = 0\text{ V}$ $V_{CE} = 1200\text{ V}$	$T_j = 25\text{ °C}$		2	$\text{mA}$
		$T_j = 125\text{ °C}$			$\text{mA}$
$C_{ies}$	$V_{CE} = 25\text{ V}$		10.8		nF
$C_{oes}$	$V_{GE} = 0\text{ V}$		0.56		nF
$C_{res}$			0.49		nF
$Q_G$	$V_{GE} = -8\text{ V...} + 20\text{ V}$		1380		nC
$R_{Gint}$	$T_j = 25\text{ °C}$		5		$\Omega$
$t_{d(on)}$	$V_{CC} = 600\text{ V}$ $I_C = 150\text{ A}$	$T_j = 125\text{ °C}$	280		ns
$t_r$	$V_{GE} = +15/-15\text{ V}$	$T_j = 125\text{ °C}$	50		ns
$E_{on}$	$R_{Gon} = 2\text{ }\Omega$	$T_j = 125\text{ °C}$	16		mJ
$t_{d(off)}$	$R_{Goff} = 2\text{ }\Omega$	$T_j = 125\text{ °C}$	560		ns
$t_f$		$T_j = 125\text{ °C}$	70		ns
$E_{off}$		$T_j = 125\text{ °C}$	24.5		mJ
$R_{th(j-c)}$	per IGBT			0.16	K/W



**SEMITRANS® 2**

## Trench IGBT Modules

### SKM195GB126D

#### Features

- Trench = Trenchgate technology
- $V_{CE(sat)}$  with positive temperature coefficient
- High short circuit capability, self limiting to  $6 \times I_C$
- UL recognized, file no. E63532

#### Typical Applications\*

- AC inverter drives
- UPS
- Electronic welders

Characteristics						
Symbol	Conditions		min.	typ.	max.	Unit
<b>Inverse diode</b>						
$V_F = V_{EC}$	$I_F = 100 \text{ A}$ $V_{GE} = 0 \text{ V}$ chiplevel	$T_j = 25 \text{ °C}$		2.00	2.50	V
		$T_j = 125 \text{ °C}$		1.80	2.30	V
$V_{F0}$	chiplevel	$T_j = 25 \text{ °C}$		1.1	1.45	V
		$T_j = 125 \text{ °C}$		0.85	1.2	V
$r_F$	chiplevel	$T_j = 25 \text{ °C}$		9	11	mΩ
		$T_j = 125 \text{ °C}$		9.5	11	mΩ
$I_{RRM}$	$I_F = 100 \text{ A}$	$T_j = 125 \text{ °C}$		86		A
$Q_{rr}$	$di/dt_{off} = 2200 \text{ A/}\mu\text{s}$	$T_j = 125 \text{ °C}$		17		μC
$E_{rr}$	$V_{GE} = -15 \text{ V}$ $V_{CC} = 600 \text{ V}$	$T_j = 125 \text{ °C}$		5.8		mJ
$R_{th(j-c)}$	per diode				0.32	K/W
<b>Module</b>						
$L_{CE}$				30		nH
$R_{CC'+EE'}$	terminal-chip	$T_C = 25 \text{ °C}$		0.75		mΩ
		$T_C = 125 \text{ °C}$		1		mΩ
$R_{th(c-s)}$	per module			0.04	0.05	K/W
$M_s$	to heat sink M6			3	5	Nm
$M_t$		to terminals M5		2.5	5	Nm
						Nm
$w$					160	g

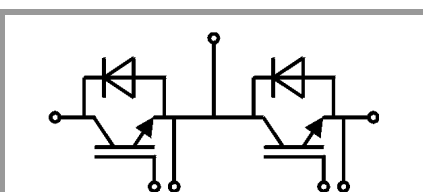

**GB**

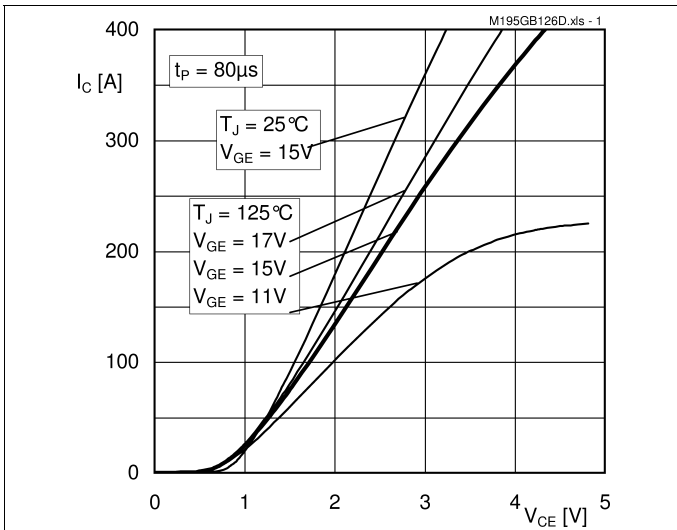

Fig. 1: Typ. output characteristic, inclusive  $R_{CC+EE}$

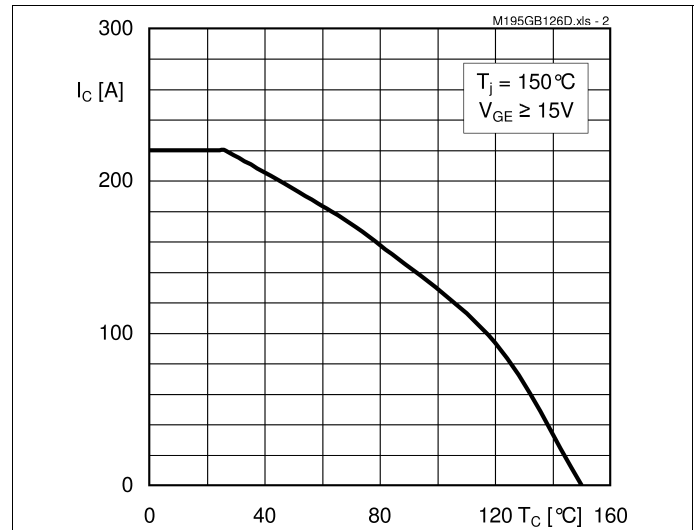

Fig. 2: Rated current vs. temperature  $I_C = f(T_C)$

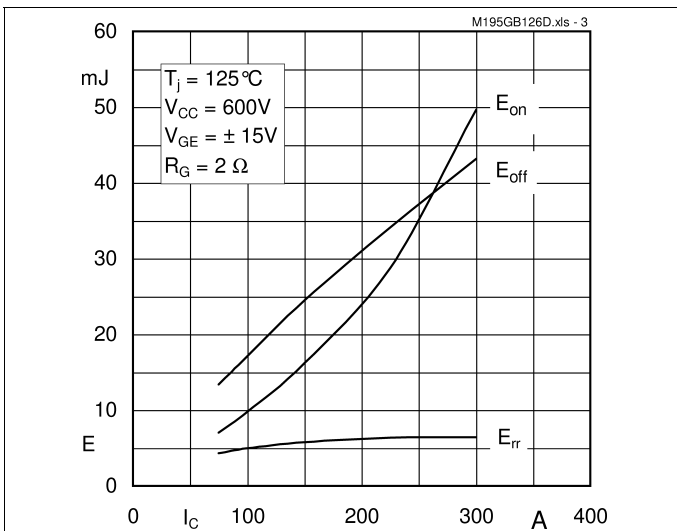

Fig. 3: Typ. turn-on /-off energy =  $f(I_C)$

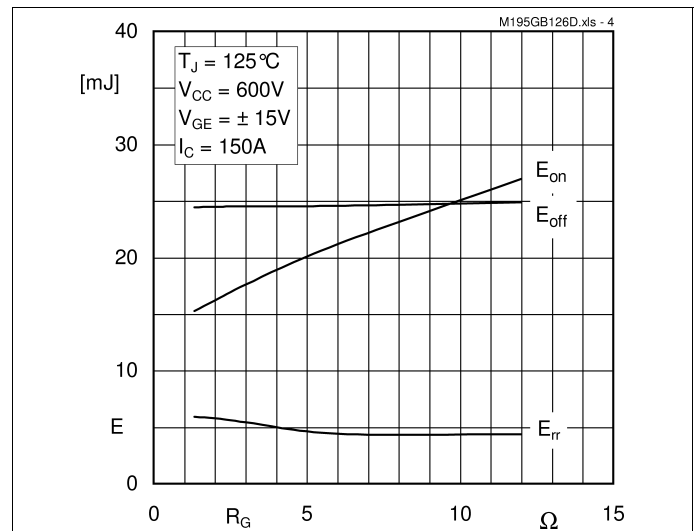

Fig. 4: Typ. turn-on /-off energy =  $f(R_G)$

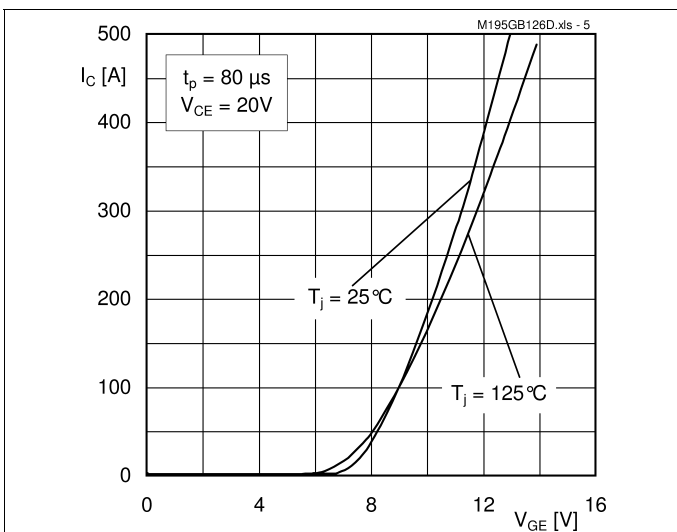

Fig. 5: Typ. transfer characteristic

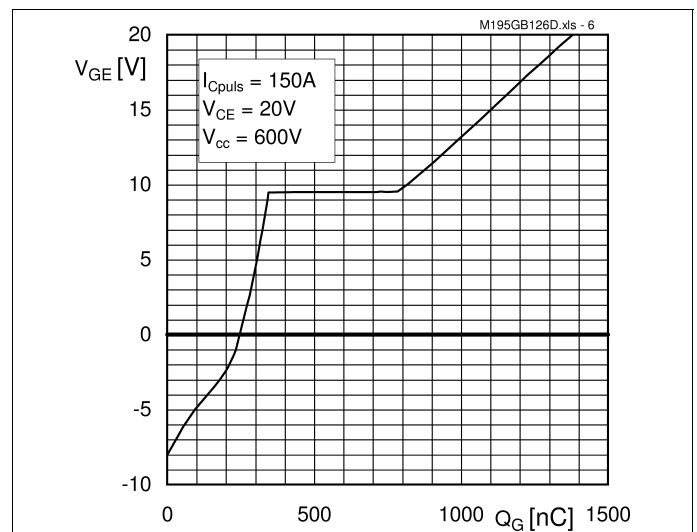
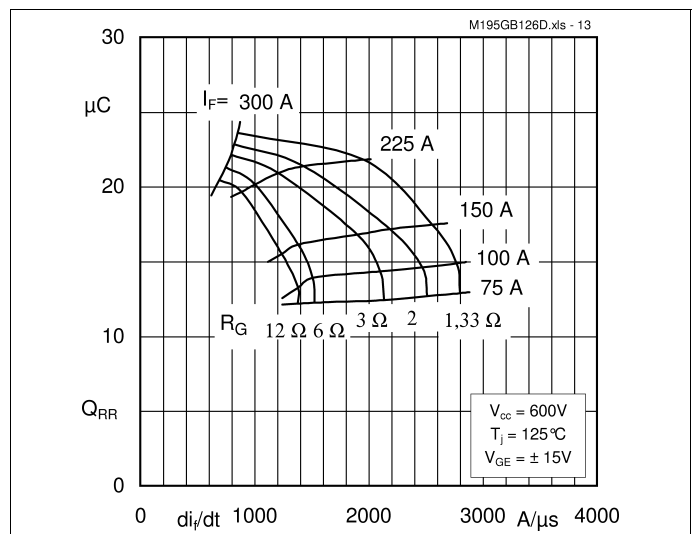
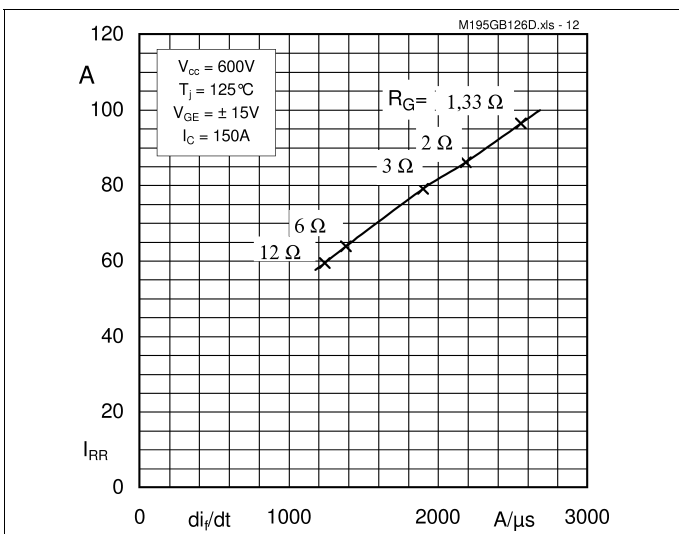
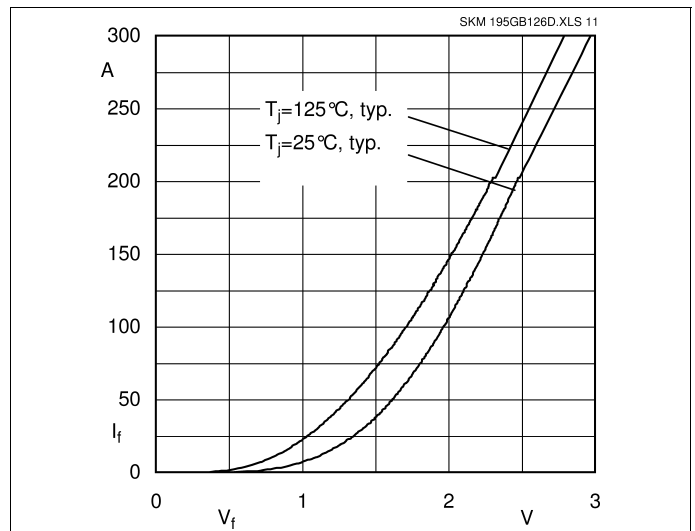
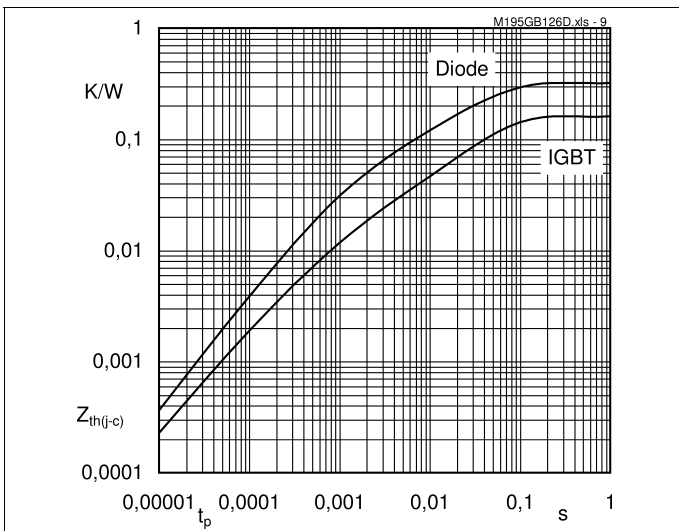
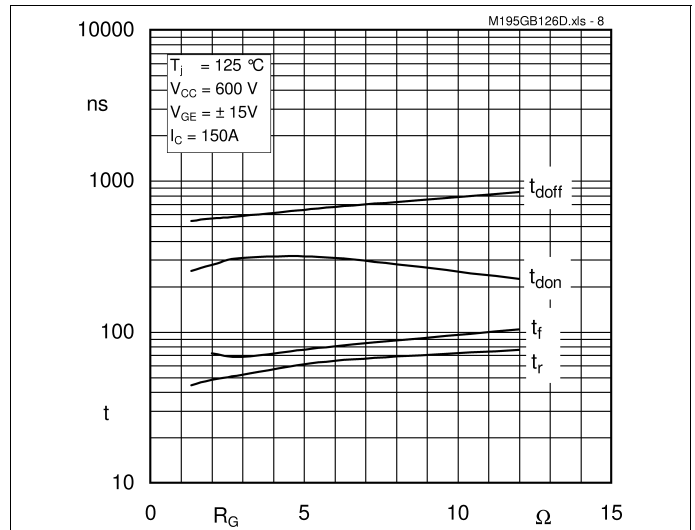
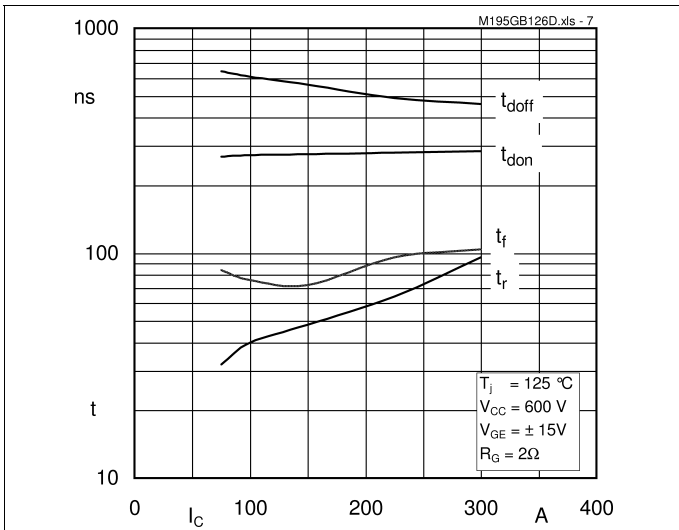
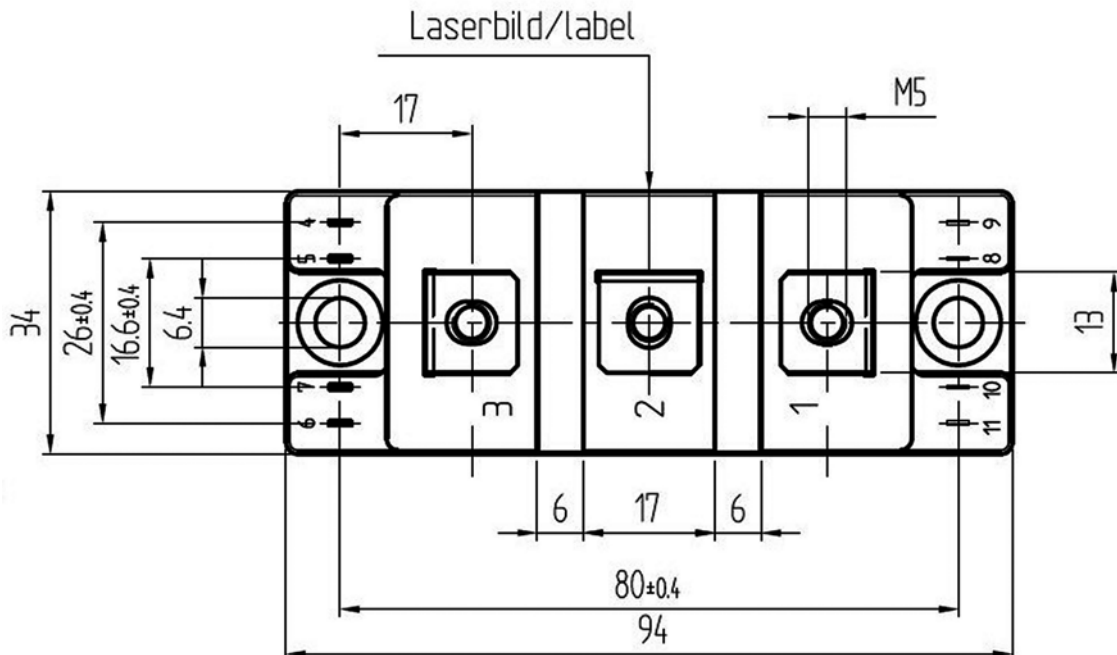
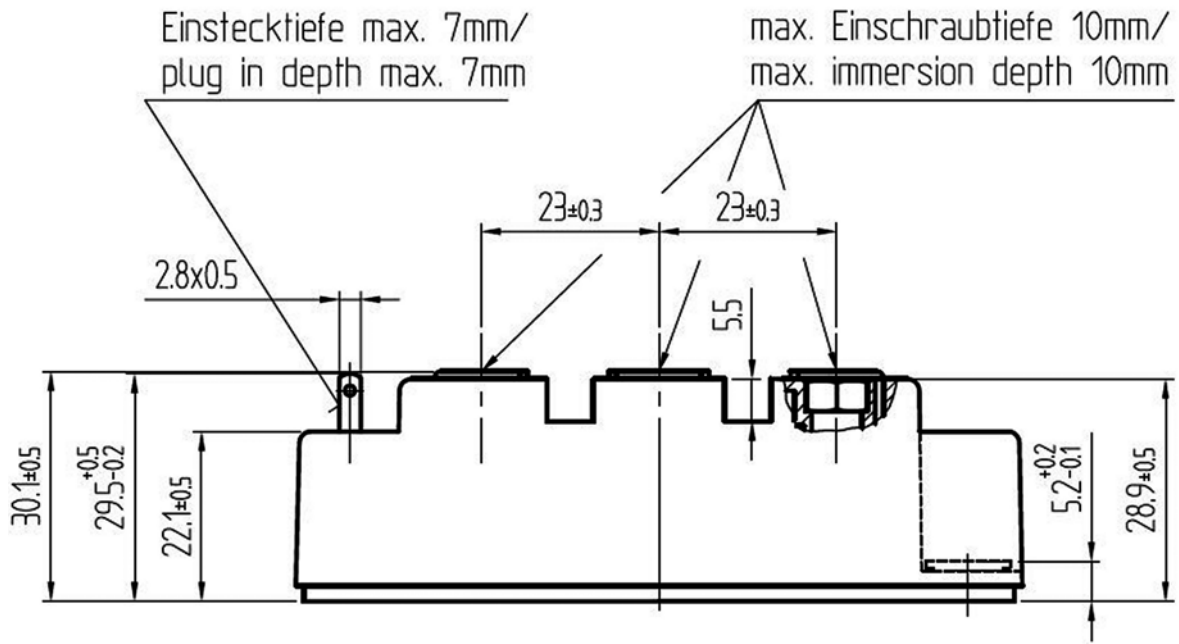

Fig. 6: Typ. gate charge characteristic



# SKM195GB126D



SEMITRANS 2

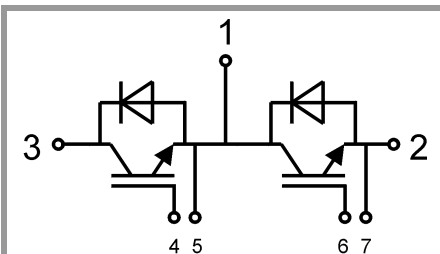

GB

This is an electrostatic discharge sensitive device (ESDS), international standard IEC 60747-1, Chapter IX

\* The specifications of our components may not be considered as an assurance of component characteristics. Components have to be tested for the respective application. Adjustments may be necessary. The use of SEMIKRON products in life support appliances and systems is subject to prior specification and written approval by SEMIKRON. We therefore strongly recommend prior consultation of our staff.